

# Data Sheet



Article number: 2307083231

Description: E+G Direct drive position indikator  
DD52R-FN-0004.0-D-C3 (Grey)

## Measures

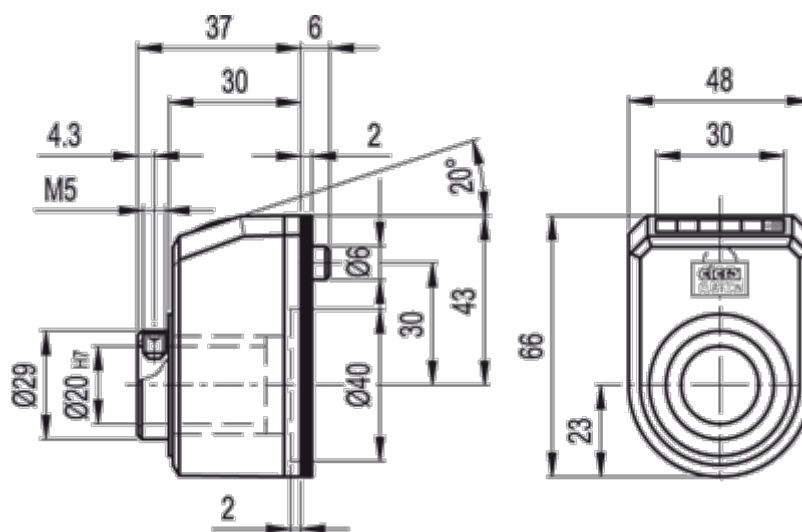

Max rpm = 625